

TD5G20120D

Silicon Carbide Schottky Diode

V_{RRM}	=	1200 V
$I_F (T_c=152\text{ }^\circ\text{C})$	=	20 A**
Q_C	=	122 nC**

Features

- 1.2kV Schottky Rectifier
- Zero Reverse Recovery Current
- High-Frequency Operation
- Temperature-Independent Switching
- Extremely Fast Switching

Benefits

- Replace Bipolar with Unipolar Rectifiers
- Essentially No Switching Losses
- High Efficiency
- Reduction of Heat Sink Requirements
- Parallel Devices Without Thermal Runaway

Applications

- Switching Mode Power Supply
- Boost Diodes in PFC
- DC/DC Converters
- AC/DC Converters
- Free Wheeling Diodes in Inverter

Package

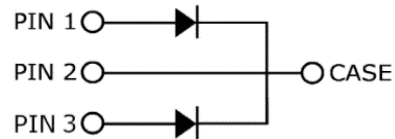
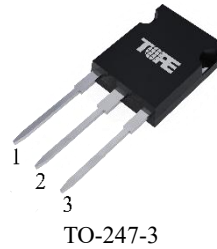

Part Number	Package	Marking
TD5G20120D	TO-247-3	TD5G20120D

Maximum Ratings (T_c = 25 °C unless otherwise specified)

Symbol	Parameter	Value	Unit	Test Conditions	Note
V_{RRM}	Repetitive Peak Reverse Voltage	1200	V		
V_{RSM}	Surge Peak Reverse Voltage	1300	V		
V_R	DC Peak Reverse Voltage	1200	V		
I_F	Continuous Forward Current	31.5/63 14.5/29 10/20	A	$T_c=25\text{ }^\circ\text{C}$ $T_c=135\text{ }^\circ\text{C}$ $T_c=152\text{ }^\circ\text{C}$	Fig. 3
I_{FSM}	Non-Repetitive Forward Surge Current	80*	A	$T_c=25\text{ }^\circ\text{C}$, $t_p=10\text{ ms}$, Half Sine Pulse	
P_{tot}	Power Dissipation	144* 62*	W	$T_c=25\text{ }^\circ\text{C}$ $T_c=110\text{ }^\circ\text{C}$	Fig. 4
T_J	Operating Junction Range	-55 to +175	°C		
T_{stg}	Storage Temperature Range	-55 to +175	°C		

*Per Leg, **Per Device

Electrical Characteristics (Per Leg)

Symbol	Parameter	Typ.	Max.	Unit	Test Conditions	Note
V_F	Forward Voltage	1.45 2.0	1.75 2.6	V	$I_F = 10\text{ A}, T_J = 25\text{ }^\circ\text{C}$ $I_F = 10\text{ A}, T_J = 175\text{ }^\circ\text{C}$	Fig. 1
I_R	Reverse Current	4 30	100 300	μA	$V_R = 1200\text{ V}, T_J = 25\text{ }^\circ\text{C}$ $V_R = 1200\text{ V}, T_J = 175\text{ }^\circ\text{C}$	Fig. 2
Q_C	Total Capacitive Charge	61		nC	$V_R = 800\text{ V}, I_F = 10\text{ A},$ $T_J = 25\text{ }^\circ\text{C}$	Fig. 6
C	Total Capacitance	800 57 42		pF	$V_R = 0\text{ V}, T_J = 25\text{ }^\circ\text{C}, f = 1\text{ MHz}$ $V_R = 400\text{ V}, T_J = 25\text{ }^\circ\text{C}, f = 1\text{ MHz}$ $V_R = 800\text{ V}, T_J = 25\text{ }^\circ\text{C}, f = 1\text{ MHz}$	Fig. 5
E_C	Capacitance Stored Energy	15.6		μJ	$V_R = 800\text{ V}$	Fig. 7

Note: This is a majority carrier diode, so there is no reverse recovery charge.

Thermal Characteristics

Symbol	Parameter	Min.	Typ.	Max.	Unit	Note
$R_{\theta JC}$	Thermal Resistance from Junction to Case		*1.04 **0.52		$^\circ\text{C/W}$	Fig.8

*Per Leg, **Per Device

Typical Performance (Per Leg)

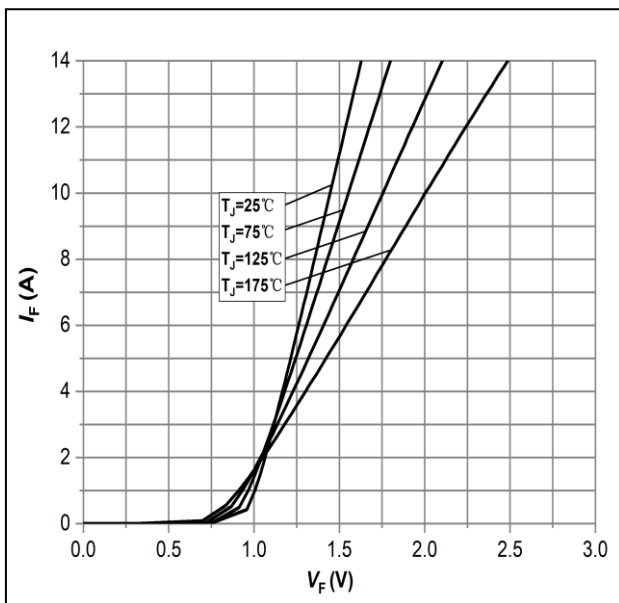

Figure 1: Forward Characteristics

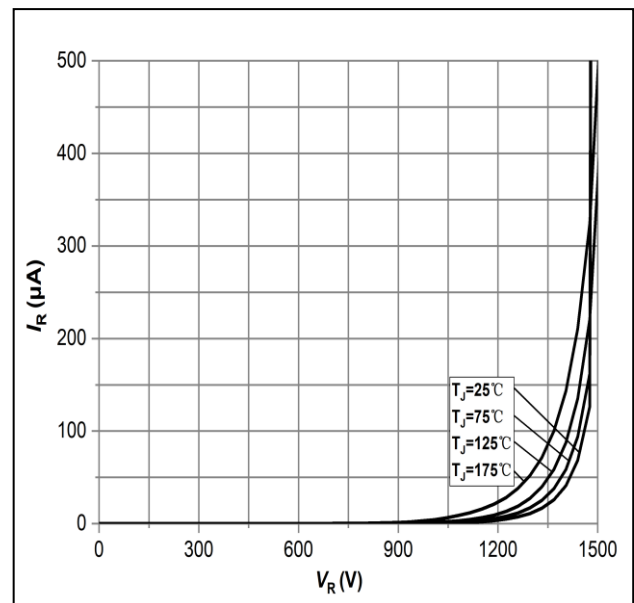

Figure 2: Reverse Characteristics

Typical Performance (Per Leg)

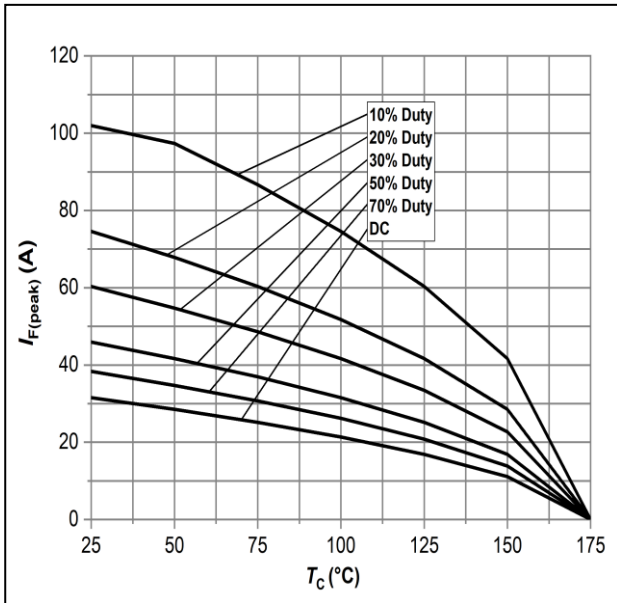

Figure 3: Current Derating

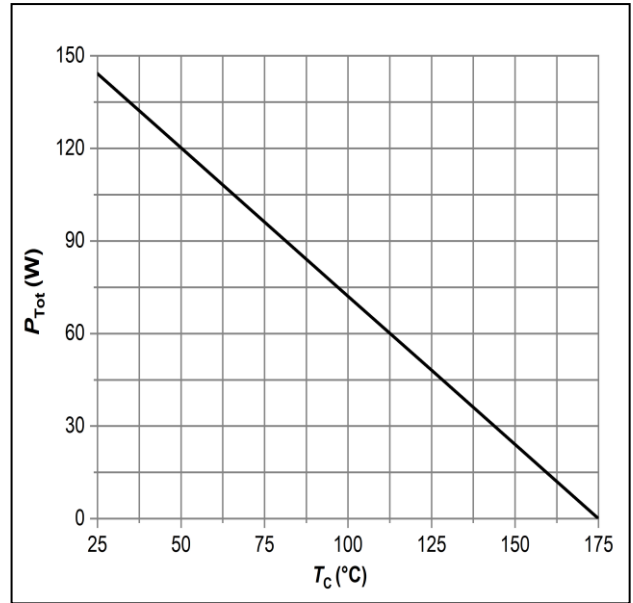

Figure 4: Power Derating

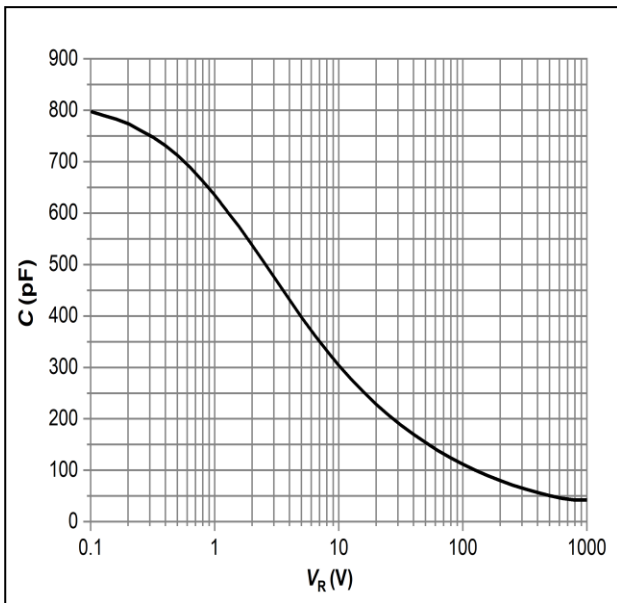

Figure 5: Capacitance vs. Reverse Voltage

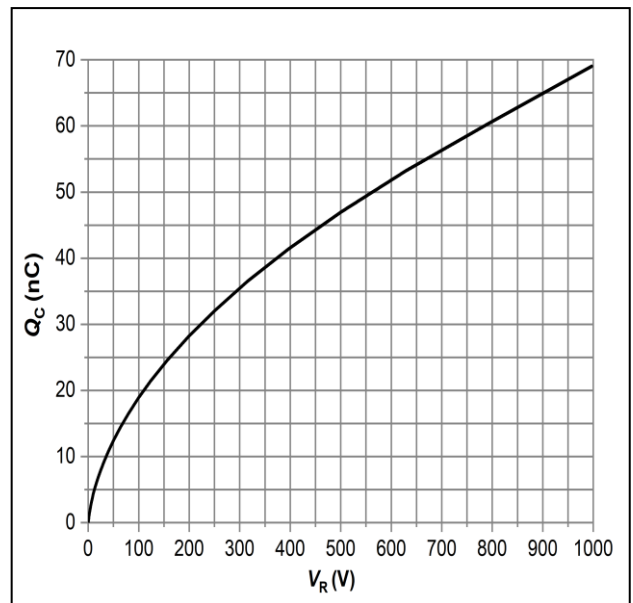

Figure 6: Total Capacitance Charge vs. Reverse Voltage

Typical Performance (Per Leg)

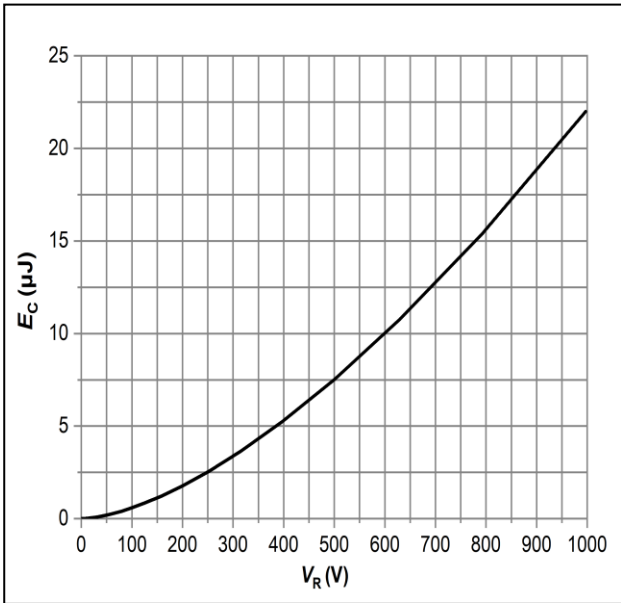

Figure 7: Typical Capacitance Stored Energy

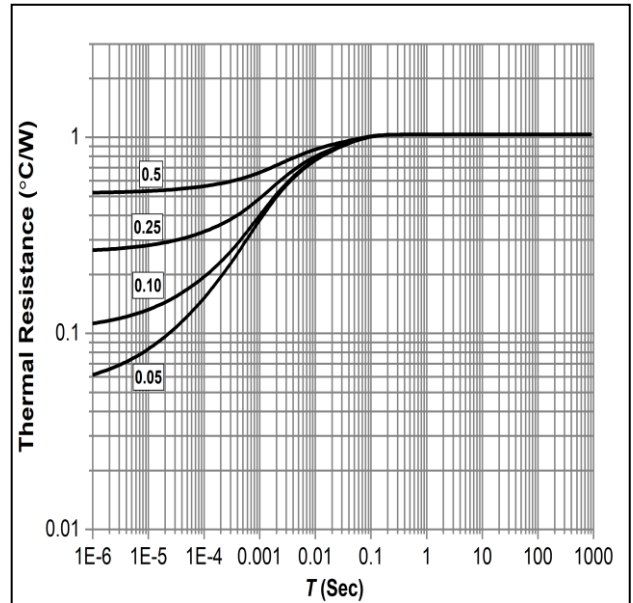
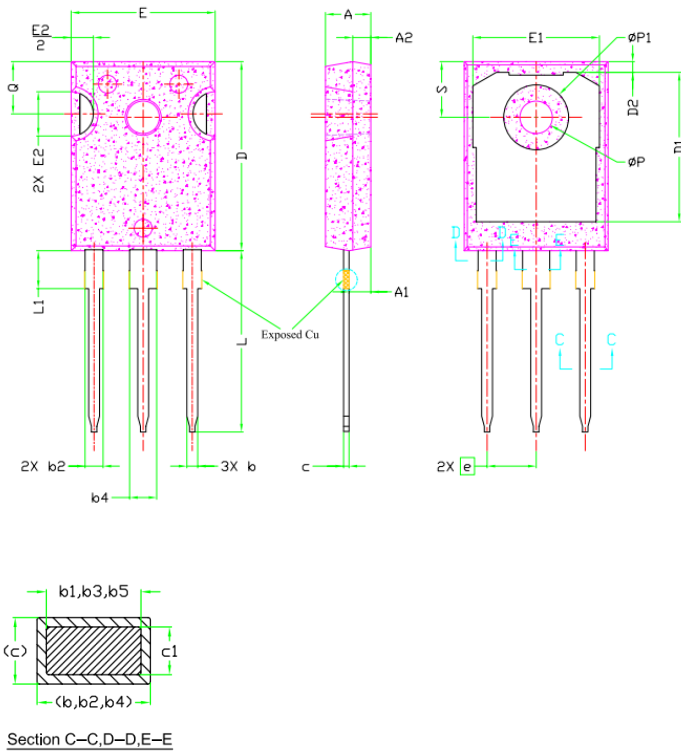

Figure 8: Transient Thermal Impedance

Package Dimensions

Package: TO-247-3



SYMBOL	DIMENSIONS			NOTES
	Min.	NOM	Max.	
A	4.83	5.02	5.21	
A1	2.29	2.41	2.55	
A2	1.50	2.00	2.49	
b	1.12	1.20	1.33	
b1	1.12	1.20	1.28	
b2	1.91	2.00	2.39	6
b3	1.91	2.00	2.34	
b4	2.87	3.00	3.22	6,8
b5	2.87	3.00	3.18	
C	0.55	0.60	0.65	6
c1	0.55	0.60	0.65	
D	20.80	20.95	21.10	4
D1	16.25	16.55	17.65	5
D2	0.51	1.19	1.35	
E	15.75	15.94	16.13	4
E1	13.46	14.02	14.16	5
E2	4.32	4.91	5.49	3
e	5.44BSC			
L	19.81	20.07	20.32	
L1	4.10	4.19	4.40	6
ØP	3.56	3.61	3.65	7
ØP1	7.19REF.			
Q	5.39	5.79	6.20	
S	6.04	6.17	6.30	

NOTE : Dimension L, M, W apply for Solder Dip Finish

Revision History

Document Version	Description of Changes
Rev.1.0	Released

关于公司和产品的更多信息请登录公司官网查询：

www.topelectronics.cn



安徽芯塔电子科技有限公司
TOPE Technologies Co., Ltd.
WuHu, Auhui, China 241002

Contact: sale@topelectronics.cn

Copyright © TOPE Technologies Co., Ltd. All rights reserved.
The information in this document is subject to change without notice.