

TD5G02120E

Silicon Carbide Schottky Diode

V_{RRM}	=	1200 V
$I_F (T_C=160\text{ }^\circ\text{C})$	=	2 A
Q_C	=	14 nC

Features

- 1.2kV Schottky Rectifier
- Zero Reverse Recovery Current
- High-Frequency Operation
- Temperature-Independent Switching
- Extremely Fast Switching

Benefits

- Replace Bipolar with Unipolar Rectifiers
- Essentially No Switching Losses
- High Efficiency
- Reduction of Heat Sink Requirements
- Parallel Devices Without Thermal Runaway

Applications

- Switching Mode Power Supply
- Boost Diodes in PFC
- DC/DC Converters
- AC/DC Converters
- Free Wheeling Diodes in Inverter

Package

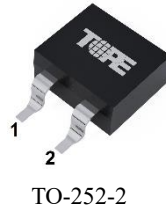

Part Number	Package	Marking
TD5G02120E	TO-252-2	TD5G02120E

Maximum Ratings (T_c = 25 °C unless otherwise specified)

Symbol	Parameter	Value	Unit	Test Conditions	Note
V_{RRM}	Repetitive Peak Reverse Voltage	1200	V		
V_{RSM}	Surge Peak Reverse Voltage	1300	V		
V_R	DC Peak Reverse Voltage	1200	V		
I_F	Continuous Forward Current	10 4.6 2	A	$T_c=25\text{ }^\circ\text{C}$ $T_c=135\text{ }^\circ\text{C}$ $T_c=160\text{ }^\circ\text{C}$	Fig. 3
I_{FSM}	Non-Repetitive Forward Surge Current	24	A	$T_c=25\text{ }^\circ\text{C}$, $t_p=10\text{ ms}$, Half Sine Pulse	
P_{tot}	Power Dissipation	58 25	W	$T_c=25\text{ }^\circ\text{C}$ $T_c=110\text{ }^\circ\text{C}$	Fig. 4
T_J	Operating Junction Range	-55 to +175	°C		
T_{stg}	Storage Temperature Range	-55 to +175	°C		

Electrical Characteristics

Symbol	Parameter	Typ.	Max.	Unit	Test Conditions	Note
V_F	Forward Voltage	1.4 1.9	1.65 2.4	V	$I_F = 2\text{ A}, T_J = 25\text{ }^\circ\text{C}$ $I_F = 2\text{ A}, T_J = 175\text{ }^\circ\text{C}$	Fig. 1
I_R	Reverse Current	1 10	50 100	μA	$V_R = 1200\text{ V}, T_J = 25\text{ }^\circ\text{C}$ $V_R = 1200\text{ V}, T_J = 175\text{ }^\circ\text{C}$	Fig. 2
Q_C	Total Capacitive Charge	14		nC	$V_R = 800\text{ V}, I_F = 2\text{ A},$ $T_J = 25\text{ }^\circ\text{C}$	Fig. 6
C	Total Capacitance	174 13 9		pF	$V_R = 0\text{ V}, T_J = 25\text{ }^\circ\text{C}, f = 1\text{ MHz}$ $V_R = 400\text{ V}, T_J = 25\text{ }^\circ\text{C}, f = 1\text{ MHz}$ $V_R = 800\text{ V}, T_J = 25\text{ }^\circ\text{C}, f = 1\text{ MHz}$	Fig. 5
E_C	Capacitance Stored Energy	3.5		μJ	$V_R = 800\text{ V}$	Fig. 7

Note: This is a majority carrier diode, so there is no reverse recovery charge.

Thermal Characteristics

Symbol	Parameter	Min.	Typ.	Max.	Unit	Note
$R_{\theta JC}$	Thermal Resistance from Junction to Case		2.6		$^\circ\text{C/W}$	Fig.8

Typical Performance

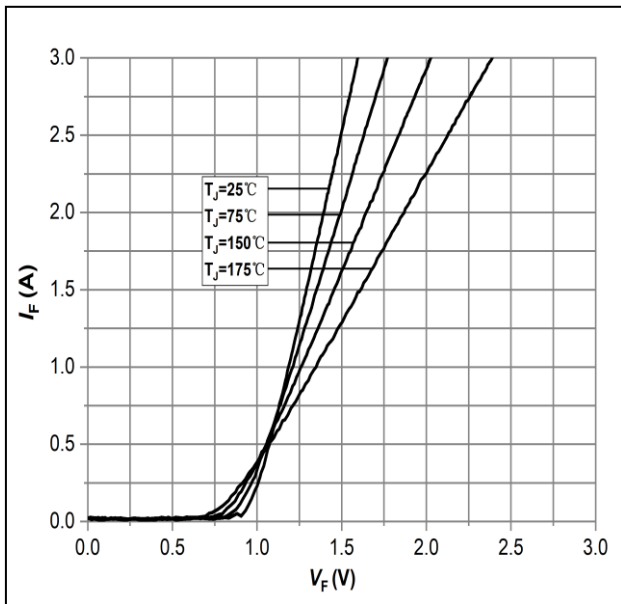

Figure 1: Forward Characteristics

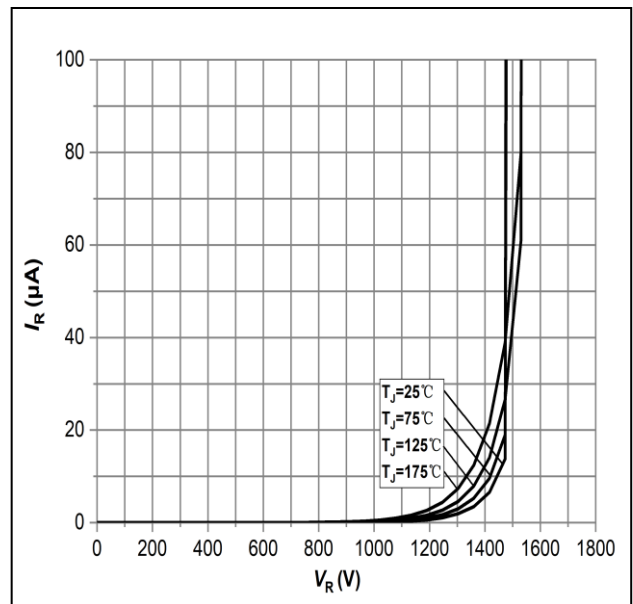

Figure 2: Reverse Characteristics

Typical Performance

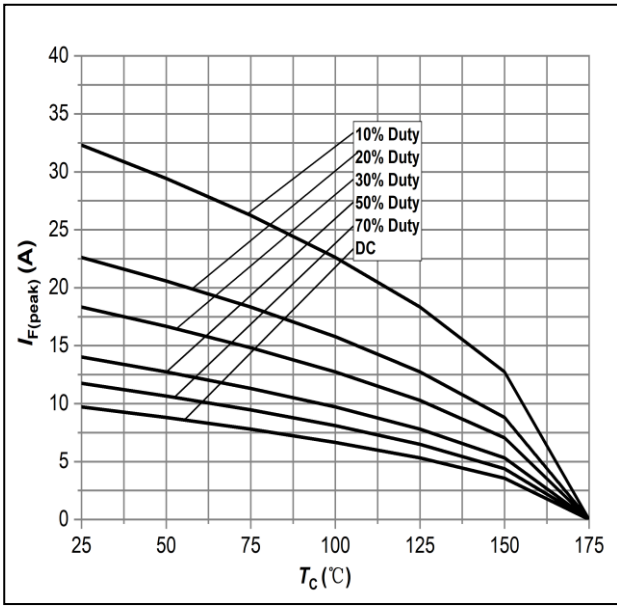

Figure 3: Current Derating

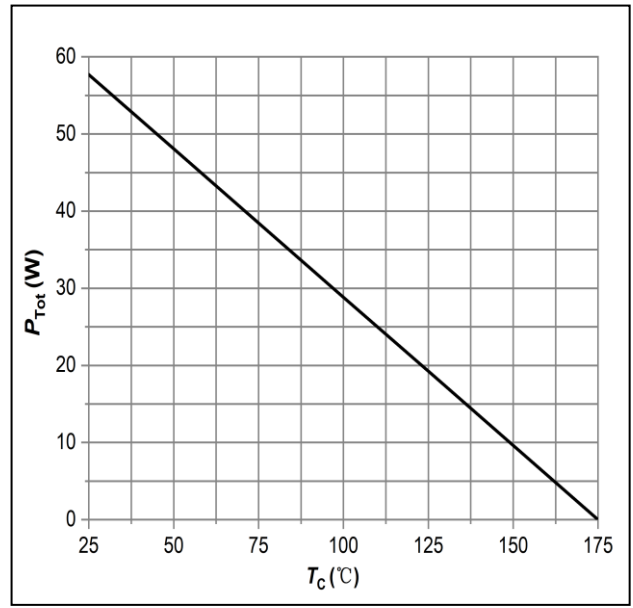

Figure 4: Power Derating

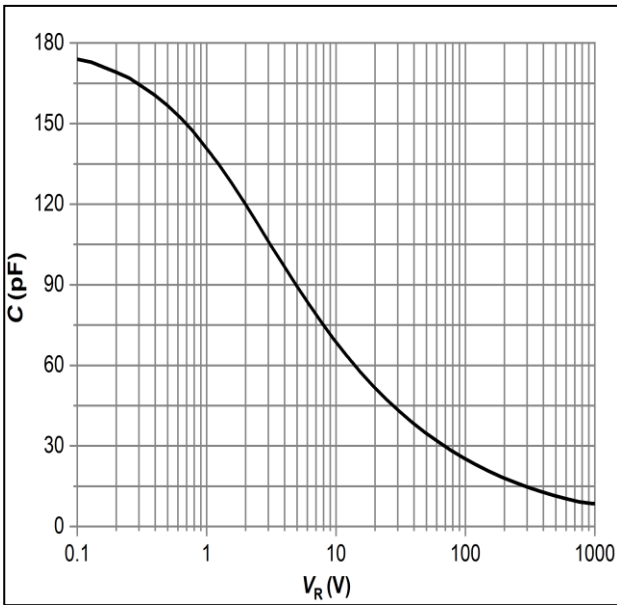

Figure 5: Capacitance vs. Reverse Voltage

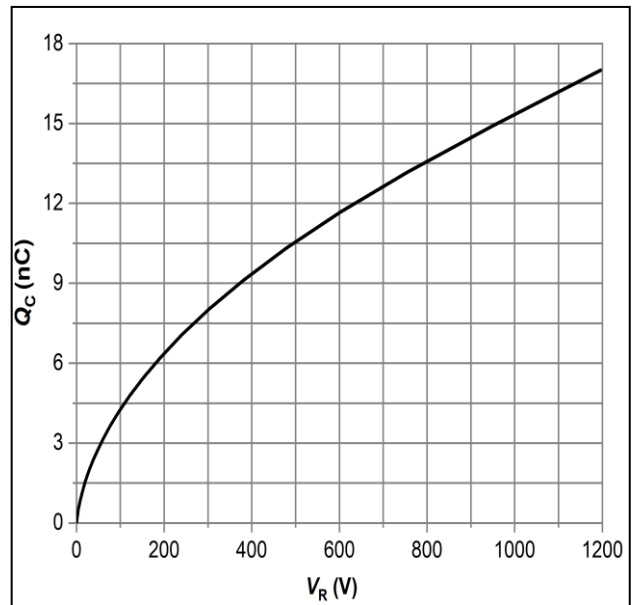

Figure 6: Total Capacitance Charge vs. Reverse Voltage

Typical Performance

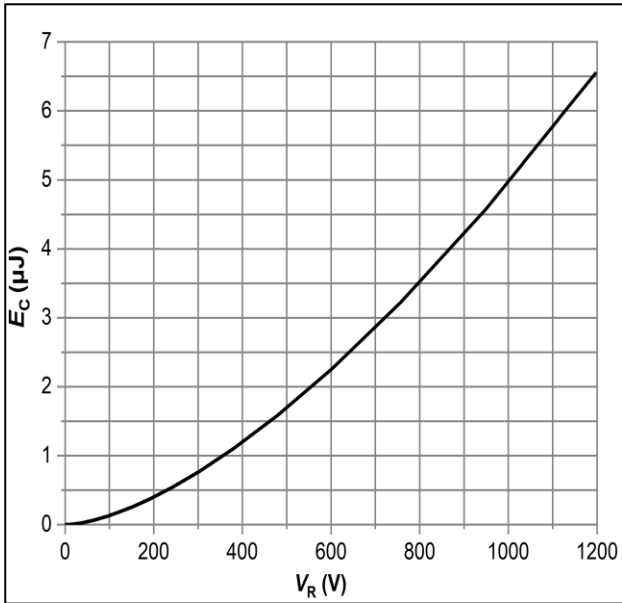

Figure 7: Typical Capacitance Stored Energy

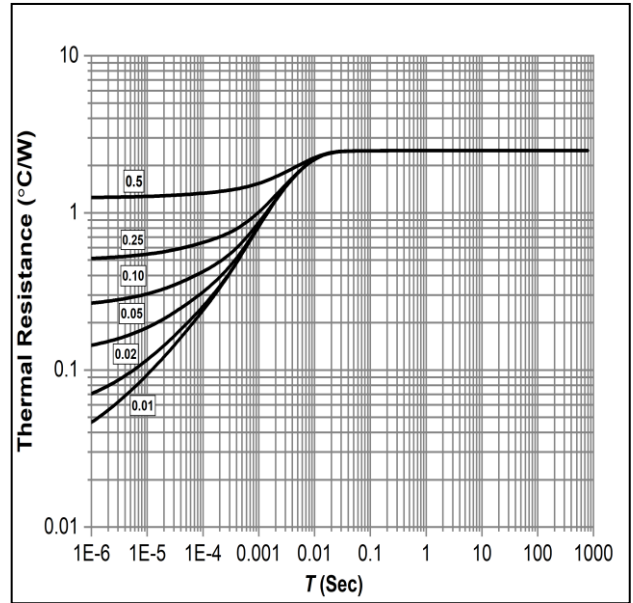
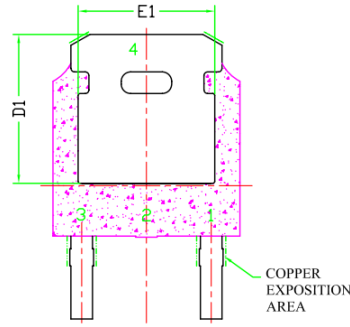
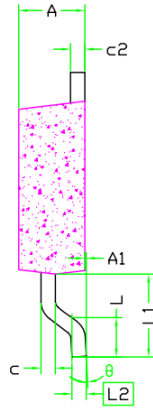
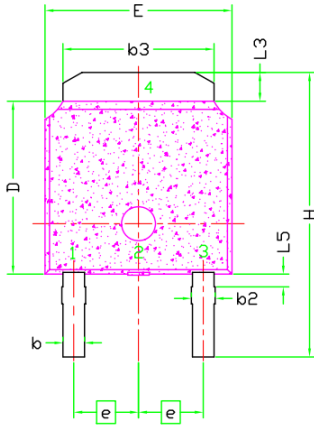

Figure 8: Transient Thermal Impedance

Package Dimensions

Package: TO-252-2



SYMBOL	DIMENSIONAL REQMTS		
	MIN	NOM	MAX
E	6.40	6.60	6.731
L	1.40	1.52	1.77
L1	2.743 REF		
L2	0.508 BSC		
L3	0.89	--	1.27
L5	--	--	--
D	6.00	6.10	6.223
H	9.40	10.00	10.40
b	0.64	0.76	0.88
b2	0.77	0.84	1.14
b3	5.21	5.34	5.46
e	2.286 BSC		
A	2.20	2.30	2.38
A1	0	--	0.127
c	0.46	0.50	0.60
c2	0.46	0.50	0.58
D1	5.21	--	--
E1	4.40	--	--
θ	0°	--	10°

Note:

1. All Dimension Are In mm.
2. Package Body Sizes Exclude Mold Flash, Protrusion Or Gate Burrs. Mold Flash, Protrusion Or Gate Burrs Shall Not Exceed 0.10 mm Per Side.
3. Package Body Sizes Determined At The Outermost Extremes Of The Plastic Body Exclusive Of Mold Flash, Gate Burrs And Interlead Flash, But Including Any Mismatch Between The Top And Bottom Of The Plastic Body.
4. The Package Top May Be Smaller Than The Package Bottom.
5. Dimension "b" Does Not Include Dambar Protrusion. Allowable Dambar Protrusion Shall Be 0.10 mm Total In Excess Of "b" Dimension At Maximum Material Condition. The Dambar Cannot Be Located On The Lower Radius Of The Foot.

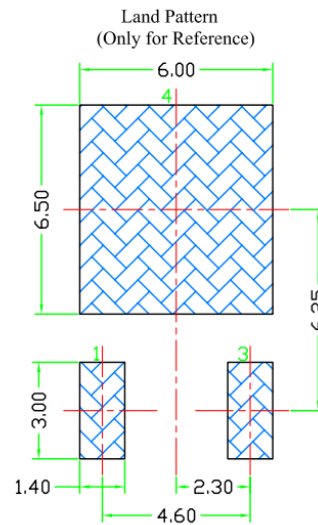

Revision History

Document Version	Description of Changes
Rev.1.0	Released

关于公司和产品的更多信息请登录公司官网查询：

www.topelectronics.cn



安徽芯塔电子科技有限公司

TOPE Technologies Co., Ltd.

WuHu, Auhui, China 241002

Contact: sale@topelectronics.cn

Copyright © TOPE Technologies Co., Ltd. All rights reserved.

The information in this document is subject to change without notice.