

# TD5G10065E

## Silicon Carbide Schottky Diode

$V_{RRM}$	=	650 V
$I_F (T_C=153\text{ }^\circ\text{C})$	=	10 A
$Q_C$	=	36 nC

### Features

- 650 V Schottky Rectifier
- Zero Reverse Recovery Current
- High-Frequency Operation
- Temperature-Independent Switching
- Extremely Fast Switching

### Benefits

- Replace Bipolar with Unipolar Rectifiers
- Essentially No Switching Losses
- High Efficiency
- Reduction of Heat Sink Requirements
- Parallel Devices Without Thermal Runaway

### Applications

- Switching Mode Power Supply
- Boost Diodes in PFC
- DC/DC Converters
- AC/DC Converters
- Free Wheeling Diodes in Inverter

### Package

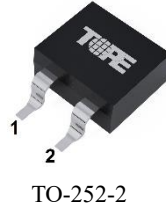

Part Number	Package	Marking
TD5G10065E	TO-252-2	TD5G10065E

### Maximum Ratings ( $T_c = 25\text{ }^\circ\text{C}$ unless otherwise specified )

Symbol	Parameter	Value	Unit	Test Conditions	Note
$V_{RRM}$	Repetitive Peak Reverse Voltage	650	V		
$V_{RSM}$	Surge Peak Reverse Voltage	650	V		
$V_R$	DC Peak Reverse Voltage	650	V		
$I_F$	Continuous Forward Current	33 15 10	A	$T_c=25\text{ }^\circ\text{C}$ $T_c=135\text{ }^\circ\text{C}$ $T_c=153\text{ }^\circ\text{C}$	Fig. 3
$I_{FSM}$	Non-Repetitive Forward Surge Current	80	A	$T_c=25\text{ }^\circ\text{C}$ , $t_p=10\text{ ms}$ , Half Sine Pulse	
$P_{tot}$	Power Dissipation	120 52	W	$T_c=25\text{ }^\circ\text{C}$ $T_c=110\text{ }^\circ\text{C}$	Fig. 4
$T_J$	Operating Junction Range	-55 to +175	$^\circ\text{C}$		
$T_{stg}$	Storage Temperature Range	-55 to +175	$^\circ\text{C}$		

### Electrical Characteristics

Symbol	Parameter	Typ.	Max.	Unit	Test Conditions	Note
$V_F$	Forward Voltage	1.4 1.65	1.7 2.2	V	$I_F = 10\text{ A}, T_J = 25\text{ }^\circ\text{C}$ $I_F = 10\text{ A}, T_J = 175\text{ }^\circ\text{C}$	Fig. 1
$I_R$	Reverse Current	2 10	50 200	$\mu\text{A}$	$V_R = 650\text{ V}, T_J = 25\text{ }^\circ\text{C}$ $V_R = 650\text{ V}, T_J = 175\text{ }^\circ\text{C}$	Fig. 2
$Q_C$	Total Capacitive Charge	36		nC	$V_R = 400\text{ V}, I_F = 10\text{ A},$ $T_J = 25\text{ }^\circ\text{C}$	Fig. 6
$C$	Total Capacitance	695 69 52		pF	$V_R = 0\text{ V}, T_J = 25\text{ }^\circ\text{C}, f = 1\text{ MHz}$ $V_R = 200\text{ V}, T_J = 25\text{ }^\circ\text{C}, f = 1\text{ MHz}$ $V_R = 400\text{ V}, T_J = 25\text{ }^\circ\text{C}, f = 1\text{ MHz}$	Fig. 5
$E_C$	Capacitance Stored Energy	4.6		$\mu\text{J}$	$V_R = 400\text{ V}$	Fig. 7

Note: This is a majority carrier diode, so there is no reverse recovery charge.

### Thermal Characteristics

Symbol	Parameter	Min.	Typ.	Max.	Unit	Note
$R_{\theta JC}$	Thermal Resistance from Junction to Case		1.25		$^\circ\text{C/W}$	Fig.8

### Typical Performance

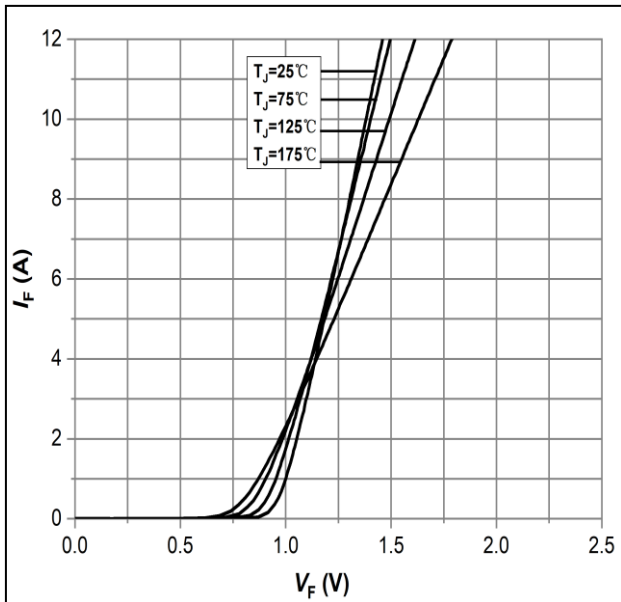

Figure 1: Forward Characteristics

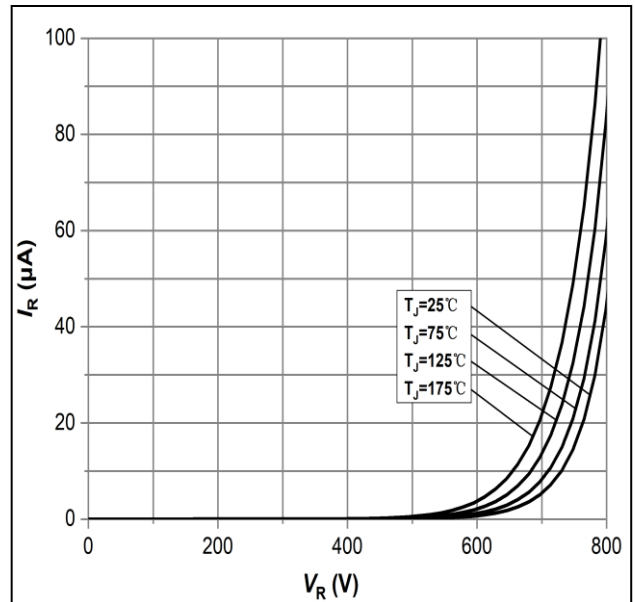

Figure 2: Reverse Characteristics

Typical Performance

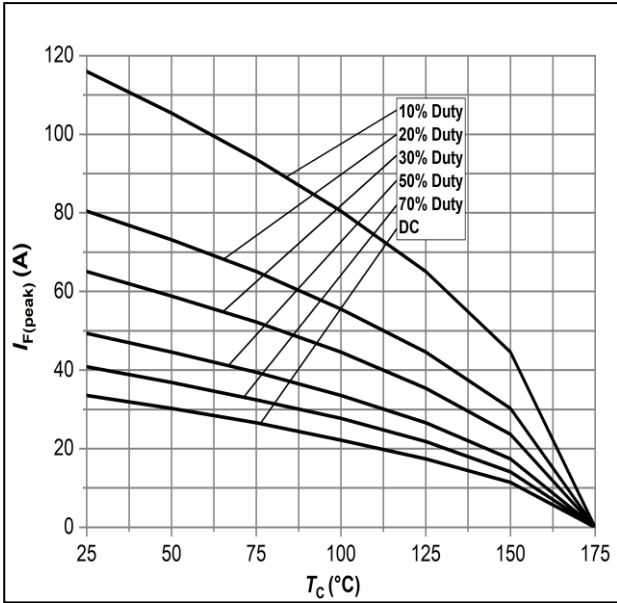

Figure 3: Current Derating

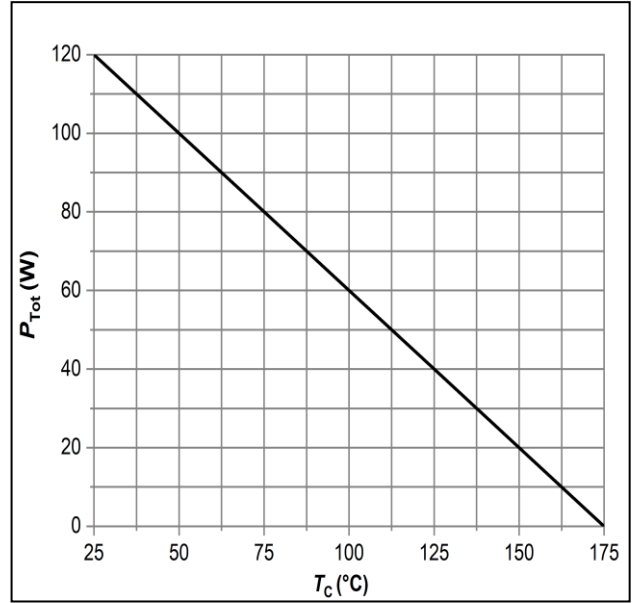

Figure 4: Power Derating

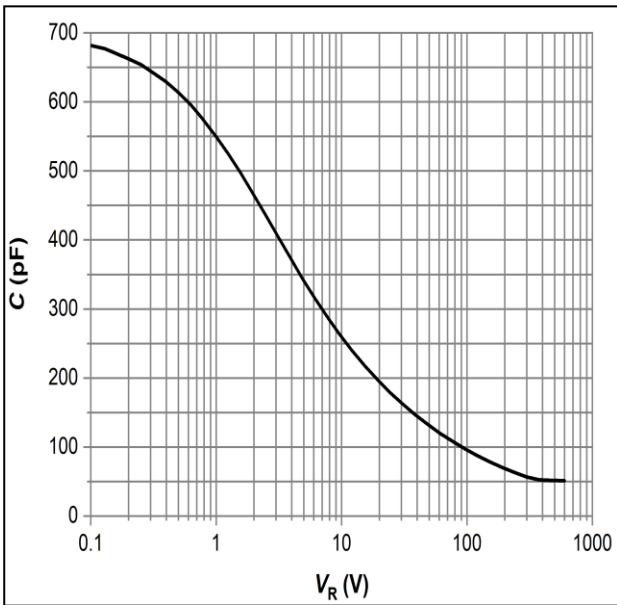

Figure 5: Capacitance vs. Reverse Voltage

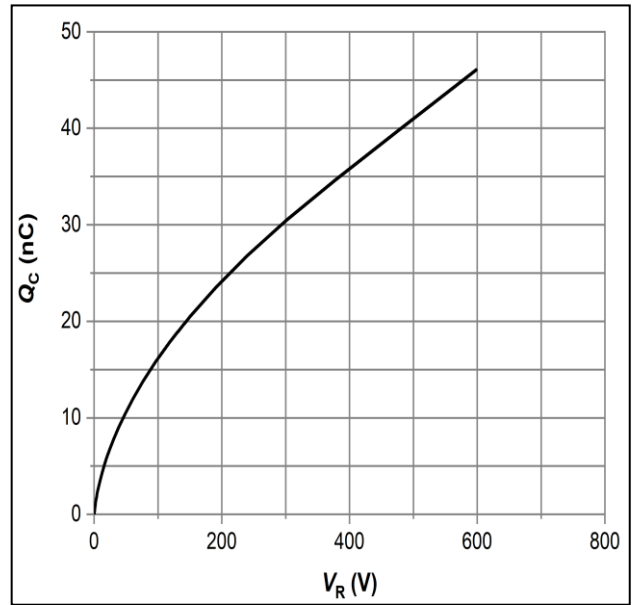

Figure 6: Total Capacitance Charge vs. Reverse Voltage

Typical Performance

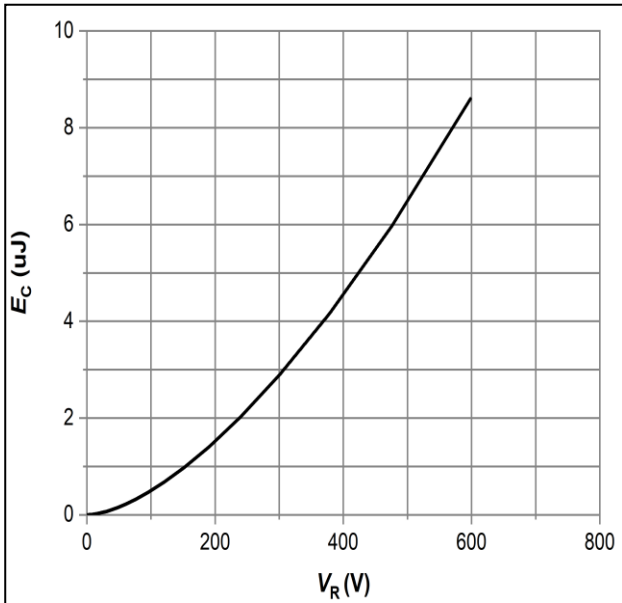

Figure 7: Typical Capacitance Stored Energy

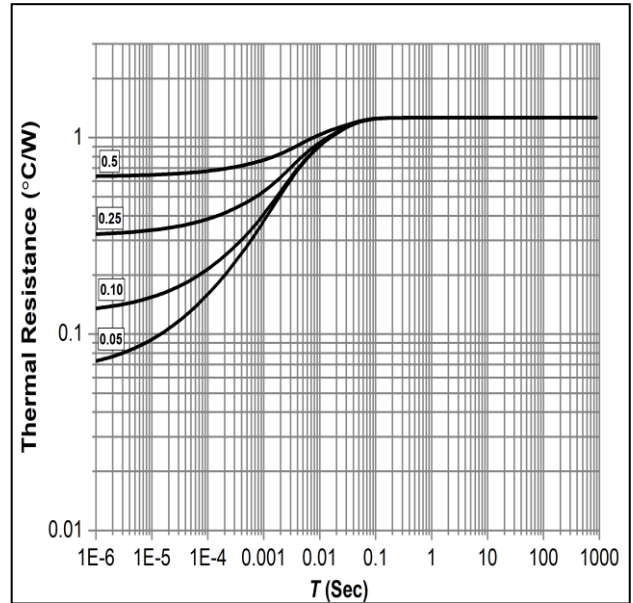
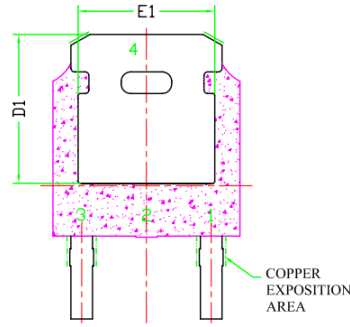
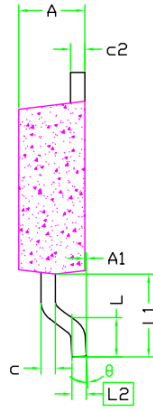
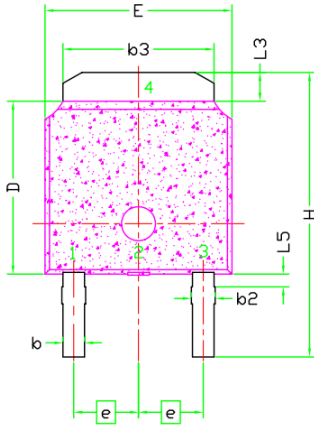

Figure 8: Transient Thermal Impedance

## Package Dimensions

Package: TO-252-2



SYMBOL	DIMENSIONAL REQMTS		
	MIN	NOM	MAX
E	6.40	6.60	6.731
L	1.40	1.52	1.77
L1	2.743 REF		
L2	0.508 BSC		
L3	0.89	--	1.27
L5	--	--	--
D	6.00	6.10	6.223
H	9.40	10.00	10.40
b	0.64	0.76	0.88
b2	0.77	0.84	1.14
b3	5.21	5.34	5.46
e	2.286 BSC		
A	2.20	2.30	2.38
A1	0	--	0.127
c	0.46	0.50	0.60
c2	0.46	0.50	0.58
D1	5.21	--	--
E1	4.40	--	--
θ	0°	--	10°

Note:

1. All Dimension Are In mm.
2. Package Body Sizes Exclude Mold Flash, Protrusion Or Gate Burrs. Mold Flash, Protrusion Or Gate Burrs Shall Not Exceed 0.10 mm Per Side.
3. Package Body Sizes Determined At The Outermost Extremes Of The Plastic Body Exclusive Of Mold Flash, Gate Burrs And Interlead Flash, But Including Any Mismatch Between The Top And Bottom Of The Plastic Body.
4. The Package Top May Be Smaller Than The Package Bottom.
5. Dimension "b" Does Not Include Dambar Protrusion. Allowable Dambar Protrusion Shall Be 0.10 mm Total In Excess Of "b" Dimension At Maximum Material Condition. The Dambar Cannot Be Located On The Lower Radius Of The Foot.

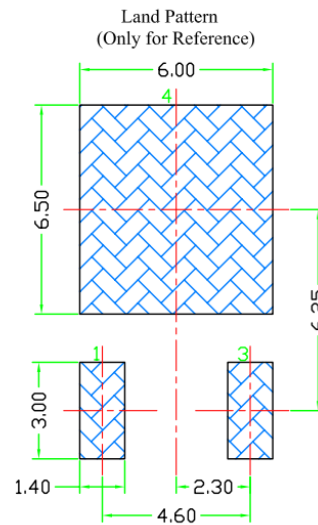

## Revision History

---

Document Version	Description of Changes
Rev.1.0	Released

---

关于公司和产品的更多信息请登录公司官网查询：

[www.topelectronics.cn](http://www.topelectronics.cn)



安徽芯塔电子科技有限公司

TOPE Technologies Co., Ltd.

WuHu, Anhui, China 241002

Contact: [sale@topelectronics.cn](mailto:sale@topelectronics.cn)

Copyright © TOPE Technologies Co., Ltd. All rights reserved.

The information in this document is subject to change without notice.